



MW10

Commercial Microwave Oven Instruction Manual



Keep these instructions!

CONTENTS

1. NAME AND FUNCTION OF PARTS	2
2. CONTROL PANEL.....	3
3. INSTALLATION.....	5
4. WARNING-This appliance must be earthed	6
5. HOW TO USE YOUR MAESTROWAVE MICROWAVE OVEN SAFELY	7
6. HINTS FOR COOKING.....	9
7. MICROWAVE OVEN COOKING KNOW-HOW	10
8. AUTO-POWER-OFF.....	10
9. TIMER (MANUAL) COOKING.....	11
10. PROGRAMMING FOR MEMORY COOKING.....	12
11. POWER LEVEL LIST	14
12. ONE TOUCH PROGRAMME COOKING.....	15
13. MEMORY RECALL.....	16
14. USABLE COOKING UTENSILS AND MATERIALS	17
15. CHECKING VARIOUS COUNTER SETTINGS & MODES	18
16. PRECAUTION WHILE HEATING	19
17. CARE AND CLEANING	20
18. WHAT TO DO IF REPAIRS ARE NEEDED	21
19. SPECIFICATIONS	22

NAME & FUNCTION OF PARTS

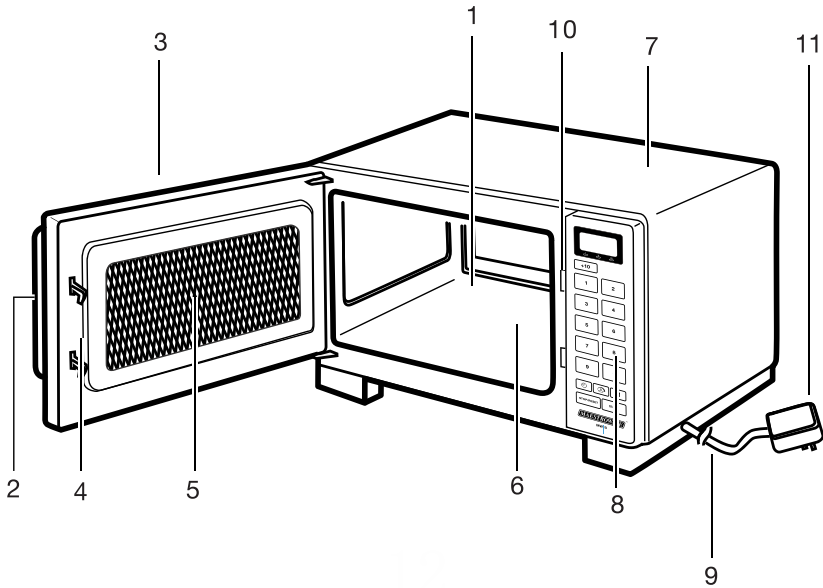

- 1. Oven Cavity**
Wipe the cavity clean each time the oven is used.
- 2. Door Handle**
- 3. Door**
- 4. Door Latch**
- 5. Shielded Viewing Window**
- 6. Ceramic Tray**
- 7. Cabinet**
- 8. Control Panel**
- 9. Power Supply Cord**
- 10. Safety Interlock System**
With built-in safety interlocks.
- 11. Power Supply Plug**

CONTROL PANEL

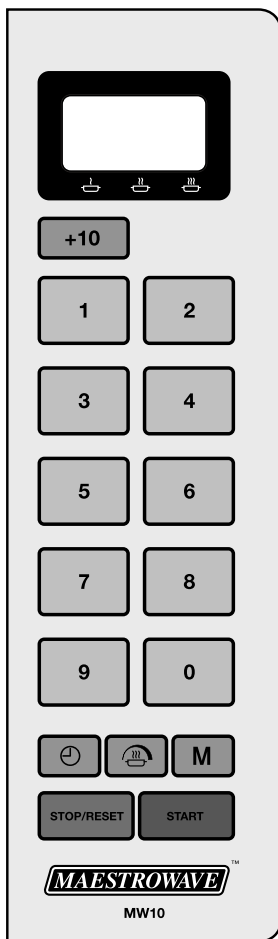

1. Display



- Displays remaining cooking time.

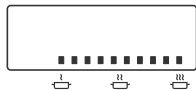

- Indicates cooking power levels.



- Gives notice that it is time to replace the Magnetron.

2. Programmable No. Plus ten key

- For setting the program number from 10 to 19.
e.g. When choosing the program number 10 or 15.

Program 10 =  +  Program 15 =  + 

3. Programme Selection Keys



- The unit is ready to begin operation as soon as the heating time has been programmed, using these ten keys (numbered 1 to 0).
- The time selected will be displayed, and “count down” after the process is begun.
- For determining power output and cooking time during programming. Please refer to pages 11 to 16.

4. Clear Key



- For cancelling setting, interrupting the setting process when a mistake has been made, or stopping cooking before the completion of the cooking process.

5. Memory Key



- For entering the desired power output and cooking time for programme cooking.

6. Power Key



- For entering the desired power output.

7. Timer Key



- For entering the desired cooking time.

8. Start Key



- For timer cooking.
- For restart at programmed cooking.

INSTALLATION

1. The oven surround and also the surround of the control panel is covered by a protective plastic film, and this should be removed prior to putting the oven into use.
2. Install the oven on a flat, level surface strong enough to safely bear the weight of the oven. To avoid the possibility of causing vibration or noise the oven must be in a stable position.
3. **Keep the oven away from heat and water**
Exposure to heat and water can lower oven efficiency and lead to malfunctioning, so be sure to install the oven away from external heat and water sources.
4. This oven conforms to EMC Directive 2014/30/EU and 2014/35/EU, however some interference may occur if it is placed too close to a radio or TV, so keep them as far apart as possible.
5. **Exhaust vents are located at the rear of the oven so maintain a minimum spacing of 5cm (2") between the oven and any adjacent surfaces at these points. In an enclosed housing, please maintain a minimum spacing of 20cm on the top.**

Covering the exhaust vent may lead to malfunctioning. Hot air flows from these vents, so be sure not to obstruct cover or let curtains come between the oven and the rear wall.

WARNING - This appliance must be earthed

IMPORTANT

The wires in this mains lead are coloured in accordance with the following code:

Earth	Green & Yellow
Neutral	Blue
Live	Brown

As the colours of the wires in the mains lead of this appliance may not correspond with the coloured markings identifying the terminals in your plug, proceed as follows:

The wire which is coloured Green or Green-and-yellow must be connected to the terminal in the plug which is marked with the letter E or by the earth symbol or coloured green-and-yellow.

The wire which is coloured white or blue must be connected to the terminal which is marked with the letter N or coloured blue.

The wire which is coloured black or brown must be connected to the terminal which is marked with the letter L or coloured brown.

THIS PLUG IS NOT WATERPROOF - KEEP DRY

This cord is already fitted with a moulded plug incorporating a fuse, the value of which is indicated on the pin face of the plug. Should the fuse need to be replaced, an ASTA approved BS1362 fuse must be used of the same rating, marked thus.



If the fuse cover is detachable, never use the plug with the cover omitted. If a replacement fuse cover is required, ensure it is the same colour as that visible on the pin face of the plug. Fuse covers are available from the Maestrowave Service Centre.

If the plug supplied is not suitable for your socket outlet, it should be cut off and destroyed*.

The end of the flexible cord should be suitably prepared and the correct plug fitted.

WARNING: A PLUG WITH BARED FLEXIBLE CORDS IS HAZARDOUS IF ENGAGED IN A LIVE SOCKET OUTLET.

HOW TO USE YOUR MICROWAVE OVEN SAFELY

Although your oven is provided with safety features, it is important to observe the following WARNING:

To reduce the risk of burns, electric shock, fire, injury to persons or exposure to excessive microwave energy:

- a) It is important not to damage or tamper with safety interlocks.
- b) Do not place any object between the oven front face and the door or allow residue to accumulate on sealing surfaces. Wipe the sealing area frequently with a mild detergent, rinse and wipe dry.
Never use abrasive powders or pads.
- c) When opened, the door must not be subjected to strain, for example, a person leaning on an opened door or any load could cause the oven to fall forward to cause injury and also damage to the door.
Do not operate the oven if it is damaged, until it has been repaired by an approved service engineer. It is particularly important that the oven door closes properly and that there is no damage to the:
 - i) Door (bent)
 - ii) Hinges and Latches (broken or loosened)
 - iii) Door seals and Sealing surfaces
- d) It is dangerous for anyone other than a properly qualified service engineer trained by MAESTROWAVE to carry out adjustments or repairs.

NOTE

It is quite normal for steam to be emitted around the door, or for misting to occur on the door, or even for water droplets to appear below the door during the cooking cycle. This is merely condensation from the heat of the food and does not affect the safety of your oven. The door is not intended to seal the oven cavity completely but its special design contributes to the complete safety of the appliance.

Note: After cooking or when you stop cooking by opening the door. The fan of the oven will run for several minutes.

OTHER SAFEGUARDS:

- 1. Never remove the cabinet.
High voltage electricity is used in this oven, so be sure not to remove the cabinet.
- 2. Be careful not to spill water over the oven, especially near the air vents.
- 3. Do not operate when there is no food in the oven.
Operation of the oven when empty will cause damage to the microwave.

4. When cooking, never use aluminum foil, metal skewers or other metallic objects in the microwave.

This may cause sparking at the point of contact, may break the glass, or cause damage to the oven walls.

5. Do not leave the oven in unattended operation when food is heated or cooked in disposable containers of plastic, paper or other combustible materials.
6. If smoke is observed, keep the oven door closed and switch off by disconnecting the oven from the power supply.
7. Do not do anything that may interfere with the operation of the upper or lower hinges and/or latches of the oven's door. Such interference causes unit malfunctions.
8. Do not use excessive force when pressing the unit's keys, or press them with metal or sharp utensils or objects.

These can damage the unit and lead to malfunctions.

9. Do not place or store things on top of the unit, as it can become quite hot during operation and there is the danger of melting or harming them.
10. Keep the power supply plug clean at all times to ensure proper operation.
11. Your MAESTROWAVE product is designed and

manufactured with high quality materials and components which can be recycled and reused. This symbol means that electrical and electronic equipment, at their end-of-life, should be disposed of separately from your household waste. Please dispose of this equipment at your local community waste collection/recycling centre. In the European Union there are separate collection systems for used electrical and electronic products. Please help us to conserve the environment we live in!

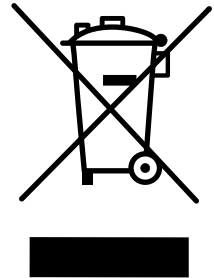

WARNING: ELECTROCUTION HAZARD HIGH VOLTAGE

Removing the cover of your microwave oven and touching an electrical part can kill you. Have a professional repair your microwave oven.

HINTS FOR COOKING

1. Microwave cooking time
 - As when cooking with other forms of heat, microwaves can cause the moisture in foods to evaporate so that the food will burn if overheated.
 - Do not set the timer for a longer time than necessary.
 - The first time you make a dish with this oven, stop cooking a bit early and check on the cooking progress.
 - Do not overcook foods.
2. Do not heat small quantities of food or dried foods for long periods of time.
 - Such foods may burn or catch fire, and the oven will also be affected in much the same way as if it were operating empty. Put a cup of water in the oven when heating such foods.
3. Always make sure that closed containers, such as jars of baby food, are opened and plastic pouches of vegetables are pierced before cooking.
 - Tightly closed containers could explode.
4. Avoid heating baby bottles or baby food jars. Transfer the food into a suitable container for the microwave oven. The food temperature should be tested before giving it to the baby.
5. Do not cook eggs in their shells because they will explode.

Prick the membrane around the yolk before frying eggs to allow steam to escape. This is because the yolk swells faster than the membrane and the egg explodes when heated quickly. Eggs cannot be boiled in this microwave oven.
6. Do not overheat.
 - During defrosting, shorten the time to avoid overcooking.
7. Never use the oven as a Clothes Drying Cabinet.

Since there is no heating time guide for drying things like paper or cloth, using the oven for this purpose may lead to oven damage or Fire!
8. When boiling water or other liquids, be sure to use wide mouthed containers. This will allow air bubbles to escape freely. Should a narrow mouthed container be used, air bubbles may combine to form a large bubble which may in turn cause the liquid to boil over. This may happen even after the cooking time has stopped.

MICROWAVE OVEN COOKING KNOW-HOW

For even cooking

- Turn bulky foods (180 ° degrees) halfway through cooking.
- When cooking two or more items, rotate them halfway through the cooking.
- When cooking tall foods, be sure to turn them upside down halfway through the cooking.
- When cooking foods with parts of different thicknesses, protect the thinner, faster-cooking part with aluminum foil halfway through the cooking to protect them from over cooking.
- When cooking soups or sauces, stir them (once or twice) halfway through the cooking.

Note: Before use, the user should check that utensils are suitable for use in microwave ovens.

AUTO-POWER-OFF

To save energy, the power supply is shut down automatically when you do not use your MAESTROWAVE microwave oven.

- When “0” is displayed on the window display
The power supply will be shut down about a minutes later.
- When “End” is displayed on the window display
The power will be shut down about 5 minutes later.
- When something other than above is displayed
The power will be shut down about 30 minutes later.

Note: When “E- ” is displayed on the window display * *
The AUTO-POWER- OFF function is not available.











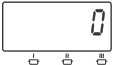

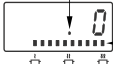

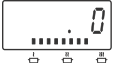

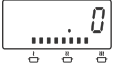
TO TURN ON POWER

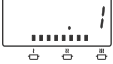
Open the door of the microwave oven.

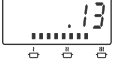
TIMER (MANUAL) COOKING

Up to 3 stages on any power level can be programmed.

1) Connect mains lead to power outlet. 2) Open the door. The interior lamp will light.

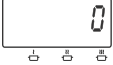
	Operation	Display window
1	Put food in suitable containers on the ceramic tray in the oven cavity and close the door.	
2	 Touch  key	 Colon. Power level bar.
3	 Touch “8” to select power level 8.	 8 power level bars are displayed.
4	 Touch  key	 No change in display.
5	 Input the desired time with the PROGRAMME keys. e.g.: Touch number “1”.	
6	 Touch number “3”.	
7	 Touch number “0”.	
8	 Then touch  to start cooking	 The time on the window display will count down.
9	Cooking time ends. Remove the food from the oven.	 The “beep” sounds. “0” shows. The oven lamp will go off.

Note: When you operate Max Power, don't touch the POWER key. Max Power operation will automatically be made so you can skip operation 2 & 3. Max input time is ten minutes.

2-stage cooking Follow steps 1 to 7, then repeat steps 2 to 7 and touch START key.















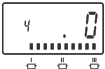

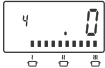
3-stage cooking Follow steps 1 to 7, then repeat step 2 to 7 two times and touch.

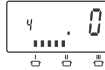
PROGRAMMING FOR MEMORY COOKING

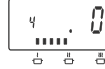
20 memory settings can be programmed for cooking the most popular dishes.
Up to 3 stages on any power level can be programmed for each memory.

When choosing the programme number from 0 to 9 :

For example, to set the following on programme No.4: Power Level 5 for 45 seconds.

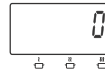
	Operation	Display window
1	 Touch  Key (twice).	 No change.
2	 Touch 4 to programme into No.4.	 Programme number.
3	 Touch  Key	 No change.
4	 Input "power level 5" with PROGRAMME key Touch number"5",	 5 power levels are displayed.
5	 Touch  Key	 No change.
6	 Input the operating time with the PROGRAMME keys Touch number "4".	
7	 Touch number "5".	
8	 Then touch  Key to complete memorising	





Note: When you operate Full Power, don't touch the POWER key. Full power operation will automatically be made so you can skip operation 4 and 5.

2-stage cooking: Follow steps 1 to 8, then repeat steps 4 to 8 and touch the MEMORY key.

3-stage cooking: Follow steps 1 to 8, then repeat steps 4 to 8 two times and touch the MEMORY key.

When choosing the program number from 10 to 19 :

(Example)To programme the cooking for 45 seconds at power level 6 for 1 serving in the memory 14.

Operation		Display window
1	M Touch M key twice.	
2	+10 Touch +10 key twice.	
	4 Touch 4 to programme into "14".	
	Repeat steps 4 to 9 above.	

NOTE: Programming for memory cooking is completed by touching memory key. If memory key is not touched, the new setting will not be programmed.

POWER LEVEL LIST

POWER LEVEL LIST	POWER (W)	Max. Input Time
Full Power	1000	10 minutes (Manual Cooking)
		6 minutes (Programme Cooking)
9	900	–
8	800	–
7	700	–
6	600	–
5	500	30 minutes
4	400	–
3	300	–
2	200	–
1	100	–
0	0	–

* You can set the power level at “0” to use the device as a timer (up to 30 minutes). In such case, the oven lamp will not light. Only the indication of remaining time will decrease every second after the start button is pressed.

Note:

1. A “beep” tone sounds whenever any key is touched.
2. If the desired numeral is not displayed, touch CLEAR key and restart (procedures) from the beginning.
3. If an operating time over the Max. Input time is selected, subsequent key operation is impossible.
4. To enter 1 minute (60 seconds) input ”100”.
5. The storing process is completed by touching MEMORY key.
If MEMORY key is not touched, the new settings will not be stored and the previous memory contents will be retained.

ONE TOUCH PROGRAMME COOKING



1. Ordinary Use

Example: When programme No.3 is programmed as:

1st input: Full power 30 sec.

2nd input: Power Level 5 for 1minute.

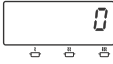
3rd input: Power Level 2 for 2minutes.

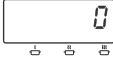
Operation		Display window
1	Place food in the oven.	 "0" appears in the display.
2	 Touch "3", then heating starts automatically.	 "3" appears in the display. The total heating time shows and countdowns.
3	Cooking time ends. Remove the food from the oven.	 Shows. The oven lamp will go off.

If the heating time is not programmed into programme selection key, "0" will appear on the display.

To select a program number from 10 to 19, press "PLUS 10" key between steps 1 & 2.

Please see the page 13 "when choosing the program number from 10 to 19 " in detail.









MEMORY RECALL

Example: When programme No.3 is programmed as:

1st stage: Full power for 30 seconds.

2nd stage: Power Level 5 for 1 minute.

3rd stage: Power Level 2 for 2 minutes.

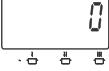
Operation		Display window
1	Open the door.	
2	 Touch number “3”.	 Show 30 seconds on max power for 1st stage.
3	 Touch number “3” again.	 Show 1 minute on level “5” power for 2nd stage.
4	 Touch number “3” again.	 Show 2 minute on level “2” power for 3rd stage.
5	 Touch  Key.	

Note:

1. Touch CLEAR key after recall .
2. If nothing is in the memory, the programme Number indicator will flash.
3. You can change the programme by operating same procedure as programming for memory cooking on page 12 to 13.
4. To select the program number from 10 to 19, press touch 10 keys between steps 1 and 2.

Please see the page 13 “when choosing the program number from 10 to 19” in detail.

USABLE COOKING UTENSILS & MATERIALS

OVENPROOF GLASS

Ovenware (treated for high intensity heat), such as mixing bowls, bread dishes, pie plates, cake plates, liquid measuring cups, casseroles, and bowls without metallic decoration.

CHINA

Bowls, cups, serving pieces, plates, and platters without metallic decoration.

POTTERY

Dishes, cups, mugs, and bowls.

PLASTIC

Plastic wrap (cling film) may be used as a cover. Lay the plastic wrap loosely over the dish and press it to the sides. The dish should be deep enough so that plastic wrap will not touch the food, also the film should be pierced to allow steam to escape.

As the food heats, it may cause the wrap to melt wherever it touches the food.

Plastic dishes, cups, semi-rigid freezer containers, and plastic bags are usable for short cooking operations. Use with care as some softening of the plastic can occur with heat from the food.

NOT SUITABLE FOR MICROWAVE COOKING

METAL UTENSILS

Metal utensils are not recommended because the metal shields the food from microwave energy on the bottom and sides, causing uneven cooking result. Metal utensils will also cause arcing and damage to the appliance.

METAL DECORATION

Metal-trimmed or banded dinnerware, casseroles, etc., should not be used. The metal trim interferes with normal cooking and damage may result.

ALUMINUM FOIL

Large sheets or pieces of aluminum foil should be avoided because they will disrupt cooking and may cause harmful arcing. However, smaller pieces may be used to cover areas such as poultry legs and wings. Any aluminum foil use should never be closer than 1 inch from side walls of oven.

WOOD

Wooden bowls and boards will become dried out when used in the microwave oven and may split or crack.













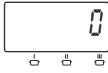









OTHER

Avoid using cracked, flawed, or defective utensils, including ovenproof glassware.

CAUTION: DO NOT USE METAL TIES ON ANY PAPER OR PLASTIC BAGS; THE TIES BECOME HOT AND COULD CAUSE A FIRE.

CHECKING VARIOUS COUNTER SETTINGS & MODES

Display shows accumulative cooking time, fan motor working time and the number of door operations by key operation. Also, you can change any remaining cooking time, buzzer sound or buzzer volume.

Operation		Display window
1	 Touch  Key	
2	 Touch  Key	
3	   Touch number "7" or "8" three times.	 E.g. The "8.88" appears in the display.
*	Stages 1 to 3 are the same for all options. Input the 4th step as follows to check or change the modes.	
4	 Input one of the following options (1-0) using the PROGRAMME SELECTION key.	 All 4 E.g. Input "1" (accumulative cooking time) will be flashing.
5	 Touch  Key	 All 4 digits will be flashing.
6	 Touch  Key again	 The total cooking time will be shown. E.g. 2.15 hours.
		 In case where options other than "7772", "8881", "8882" were selected in step 4, appears in the display "0" confirming that the new setting has been accepted.
7	 Touch  Key	 Touch the CLEAR key to clear display for the option "7772", "8881" and "8882".

The following options can be selected by inputting one of the numbers below at the operation step 3”and step “4”. “

INPUT OPTIONS

- 77.72 Accumulative operation time of fan motor. (*units of 1 hour*)
- 77.73 To enable the buzzer after cooking is done.
- 77.74 To disable the buzzer after cooking is done.
- 77.75 After the end of the process shows “End”
- 77.76 After the end of the process shows “0”
- 88.81 Accumulative cooking time.
- 88.82 The number of door operations. (*100 times*)
- 88.83 Indication of remaining cooking time
(*When cooking is interrupted by door opening*).
- 88.84 To cancel remaining cooking time
(*When cooking is interrupted by door opening*).
- 88.85 Tone of the buzzer on cooking completion. (*Pip, Pip, Pip*)
- 88.86 Tone of the buzzer on cooking completion. (*Peep*)
- 88.87 The volume of the buzzer. (*Quiet*)
- 88.88 The volume of the buzzer. (*Medium*)
- 88.89 The volume of the buzzer. (*Loud*)
- 88.80 The volume of the buzzer. (*None*)

PRECAUTION WHILE HEATING

- 1. To check food during cooking**
Open the door halfway through the process, and cooking will stop.
Remaining time will be displayed on the window display.
- 2. To resume cooking after checking food doneness.**
Close the door and touch START key.
- 3. To stop cooking halfway through the process.**
Touch CLEAR key.
- 4. When a programme not entered in the unit's memory is selected**
“0” will appears and programme number will flash on the window display.

CARE & CLEANING

ALWAYS KEEP THE OVEN CLEAN

1. Cleaning the glass viewing window, the inner door panel and oven front face.
For best performance and to maintain the high degree of safety the inner door panel and oven front face should be free of food or grease build-up.
Wipe these parts with a mild detergent, rinse and wipe dry.
Never use abrasive powders, pads or chemicals.
2. Cleaning the control panel and plastic parts.
Do not apply a detergent or an alkaline liquid spray to the control panel and plastic parts, as this may cause damage to these parts.
Use a dry cloth (not a soaked cloth) to clean these parts.
3. Cleaning the oven interior.
After use be sure to clean up spilled liquids, spattered oil and food debris as quickly as possible. If the oven is used when dirty, efficiency drops and the dirt gets stuck on the oven surface and may cause bad odours. Clean the interior with a cloth soaked in luke-warm water with a mild detergent dissolved in it, then rinse the soap off with a damp cloth.
In particular, the bottom of the oven interior tends to get stained from food. Be sure to keep this area clean.

CAUTION: Do not wipe plastic and painted sections of the oven with bleach, thinners or other cleaning agents, as this may cause damage.

WHAT TO DO IF REPAIRS ARE NEEDED

1. If any of the following appear, check for a problem.

“U-50” flashes in the display window.

When using programme Selection Keys the key must be touched within 1 minute of closing the door.

After inserting the power plug into the wall outlet, open and close the door and then touch the key.

Open and close the door, and then touch the key before 1 minute passes.

The purpose of this function is to prevent operation when there is no food in the oven.

2. Normal operation:

Cooling fan operates for a while after heating has completed or heating has been stopped by opening door or touch CLEAR key during operating.

Cooling fan operating continues for five minutes to keep the electronic components cool.

When door is open. Cooling fan operating continues for two minutes to keep the electronic components cool.

3. Abnormal operation:

Get in contact with your nearest Service centre or retailer.

See **www.maestrowave.com** for details.

This oven is provided with self-diagnostic function.

- When the window display indicates the error code “E (example: E-31), it shows to need repairing by a technical service engineer. Remove the power supply plug from wall outlet and call a Service Center.
- When the magnetron indicator in control panel lights, it shows that remaining magnetron life became short. Call a Service Center to replace the magnetron before it becomes defective.

On no account remove or interfere with any parts or screws – THIS COULD PROVE VERY DANGEROUS.

Make the following simple check-up before contacting a MAESTROWAVE Service Center.

If the interior lamp does not light when one of the programme selection key is touched:

1. Make sure that the power supply cord is securely plugged in.
2. Check the fuse in the plug top and ensure the plug top is wired correctly.
Note: The appliance must be protected by a fuse.
3. Make sure that the door is completely closed.
4. Make sure that a programme has been stored.

If the interior lamp lights and the appropriate power select or preset cooking indicator is illuminated but the food is not heated:

1. Make sure that the food is not completely covered with a metal container.

Abnormal noise during operation.

1. Make sure that sparking during microwave cooking is not caused by using unsuitable utensils of metal or having metal bands or trimmings, or aluminum foil or skewers.
2. Make sure that the tray is set in the oven properly.
3. Check whether foods or containers are touching inside walls of the oven.

If smoke is observed, keep the oven door closed and switch off by disconnecting the oven from the power supply.

SPECIFICATIONS

Microwave power output	1000 W-100W
Microwave frequency	2450 MHz
Outer dimensions (mm)	490w 460d 320h
Cavity dimensions (mm)	320w 330d 230h
Weight	19.5Kg (43lbs)



- This oven complies with the requirements of Directives 2014/30/EU and 2014/35/EU.
- As part of a policy of continuous improvement we reserve the right to alter design and specification without notice.
- No part of this publication may be reproduced, stored in a retrieval system or transmitted in any form, electrical, mechanical, photocopied, recorded, translated or other means without prior permission of MAESTROWAVE.
- The illustrations, technical information and data contained in this publication to our best knowledge, were correct at the time of going to print. The right to change specifications, at any time, without notice, is reserved as part of continuous development and improvement.



www.maestrowave.com

Sole Distributor
R H Hall (Microwave) Ltd
Hallco House, Pitstone Green Business Park,
Pitstone LU7 9GY
Telephone: 01296 663400
Fax: 01296 663403
E-mail: maestrowave@rhhall.com